

NORMA

Authorized distributor
of EURORICAMBI



Catalog de >>>>>
PRODUSE

2022



Despre **COMPANIA**



DE LA PIESE DE CAMION PÂNĂ LA PIESE SPECIALE ALE CUTIEI DE VITEZE

Sc NORMA Srl este o firmă cu peste 15 ani de experiență în domeniul comerțului de piese pentru camioane, accesorii și piese cutii de viteze pentru camioane. Vă oferim un parteneriat stabil, pe termen lung și oferim una dintre cele mai variată gamă de piese pentru camioane.

Sediul:

RO. Odorheiu Secuiesc, str. Nicolae Bălcescu, nr. 69/C
office@norma.com.ro | 0744 505 374

Site-ul oficial

www.norma.com.ro

CUPRINS



APARATOARE DE NOROI	4 - 12
PIESE DE REMORCĂ	14 - 31
ACCESORII DE CONEXIUNE	32 - 35
ACCESORII DE SIGURANȚĂ	36 - 40
SISTEME DE PRINDERE DE ÎNCĂRCARE	41 - 43
ECHIPAMENT ADIȚIONAL	44 - 47
ELEMENTE SISTEM PNEUMATIC	49 - 51
ACCESORII BARĂ SPATE	51 - 52
DIAGrame TAHOGRAF	53



■ Aripă din plastic cu suport reglabil

Descriere	Cod produs	Lățime	Lungime	Grosime
Aripă din plastic	DK2210	460 mm	460 mm	460 mm
Aripă din plastic	DK2220	460 mm	460 mm	460 mm



■ Aripă din plastic cu suport reglabil

Descriere	Cod produs	Lățime	Lungime	Grosime
Aripă din plastic	DK1222	460 mm	600 mm	125 mm
Aripă din plastic	DK1224	460 mm	600 mm	125 mm



■ Aripă din plastic cu suport reglabil

Descriere	Cod produs	Versiuni	Lățime	Diametru	Lungime
Aripă din plastic	DK1510		270 mm	1300 mm	840 mm
Aripă din plastic	DK1515	cu linie alb	410 mm	1350 mm	860 mm
Aripă din plastic	DK1615		410 mm	1350 mm	860 mm
Aripă din plastic	DK1520		450 mm	1350 mm	860 mm



Descriere	Cod produs	Versiuni			
			Lățime	Diametru	Lungime
Aripă din plastic	DK1510		270 mm	1300 mm	840 mm
Aripă din plastic	DK1515		410 mm	1350 mm	860 mm
Aripă din plastic	DK1615	cu linie alb	410 mm	1350 mm	860 mm
Aripă din plastic	DK1520		450 mm	1350 mm	860 mm
Aripă din plastic	DK1620	cu linie alb	450 mm	1350 mm	860 mm
Aripă din plastic	DK1530		500 mm	1620 mm	1000 mm
Aripă din plastic	DK1535		500 mm	1700 mm	1100 mm
Aripă din plastic	DK1635	cu linie alb	500 mm	1700 mm	1100 mm
Aripă din plastic	DK1540		550 mm	1700 mm	1100 mm
Aripă din plastic	DK1640	cu linie alb	550 mm	1700 mm	1100 mm
Aripă din plastic	DK1545		550 mm	1780 mm	1120 mm
Aripă din plastic	DK1550		550 mm	1900 mm	1280 mm
Aripă din plastic	DK1650	cu linie alb	550 mm	1900 mm	1280 mm
Aripă din plastic	DK1555		600 mm	1700 mm	1100 mm
Aripă din plastic	DK1655	cu linie alb	600 mm	1700 mm	1100 mm
Aripă din plastic	DK1560		600 mm	1840 mm	1160 mm
Aripă din plastic	DK1565		600 mm	1900 mm	1280 mm
Aripă din plastic	DK1665	cu linie alb	600 mm	1900 mm	1280 mm
Aripă din plastic	DK1570		650 mm	1900 mm	1280 mm
Aripă din plastic	DK1670	cu linie alb	650 mm	1900 mm	1280 mm
Aripă din plastic	DK1575		430 mm	1900 mm	1300 mm
Aripă din plastic	DK1675	cu linie alb	430 mm	1900 mm	1300 mm
Aripă din plastic	DK1580		430 mm	2125 mm	1300 mm
Aripă din plastic	DK1680	cu linie alb	430 mm	2125 mm	1300 mm
Aripă din plastic	DK1585		670 mm	2125 mm	1340 mm
Aripă din plastic	DK1685	cu linie alb	670 mm	2125 mm	1340 mm



■ Aripă din plastic fără suport reglabil

Descriere	Cod produs			
		Lățime	Lungime	Grosime
Aripă din plastic	DK1210	460 mm	500 mm	150 mm
Aripă din plastic	DK1220	460 mm	600 mm	150 mm
Aripă din plastic	DK1230	590 mm	530 mm	125 mm
Aripă din plastic	DK1240	670 mm	680 mm	125 mm

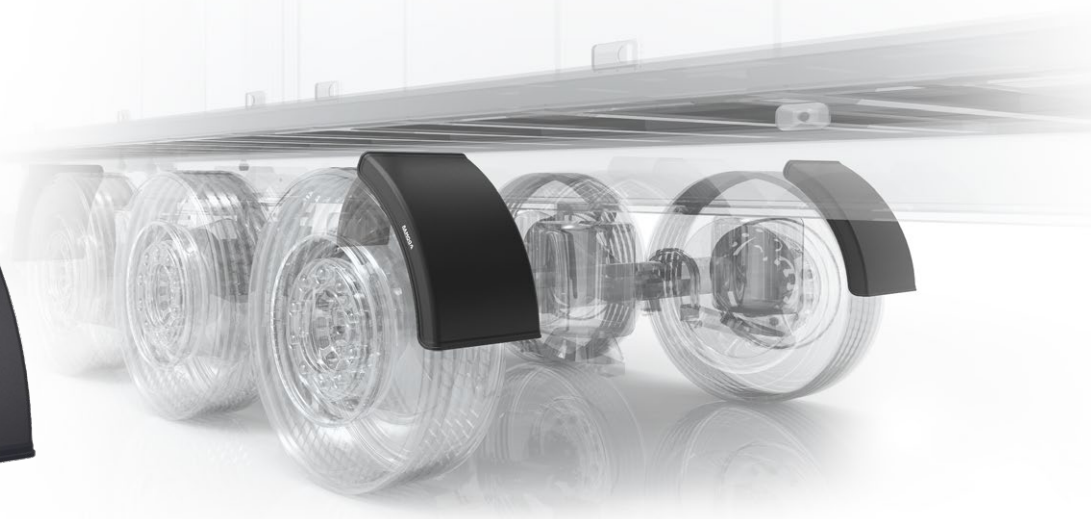

■ Aripă din plastic fără suport reglabil

Descriere	Cod produs	Versiuni	Lățime	Diametru	Lungime
Aripă din plastic	DK1045		550 mm	800 mm	735 mm
Aripă din plastic	DK1145	cu linie alb	550 mm	800 mm	735 mm
Aripă din plastic	DK1050		600 mm	800 mm	740 mm
Aripă din plastic	DK1150	cu linie alb	600 mm	800 mm	740 mm
Aripă din plastic	DK1055		670 mm	800 mm	750 mm
Aripă din plastic	DK1155	cu linie alb	670 mm	800 mm	750 mm
Aripă din plastic	DK1060		430 mm	1000 mm	910 mm
Aripă din plastic	DK1160	cu linie alb	430 mm	1000 mm	910 mm
Aripă din plastic	DK1065		670 mm	1000 mm	905 mm
Aripă din plastic	DK1165	cu linie alb	670 mm	1000 mm	905 mm
Aripă din plastic	DK1110	cu linie alb	430 mm	700 mm	670 mm
Aripă din plastic	DK1115	cu linie alb	500 mm	700 mm	650 mm
Aripă din plastic	DK1120	cu linie alb	550 mm	700 mm	635 mm
Aripă din plastic	DK1125	cu linie alb	600 mm	700 mm	660 mm
Aripă din plastic	DK1130	cu linie alb	670 mm	700 mm	670 mm
Aripă din plastic	DK1135	cu linie alb	430 mm	800 mm	755 mm
Aripă din plastic	DK1140	cu linie alb	500 mm	800 mm	730 mm

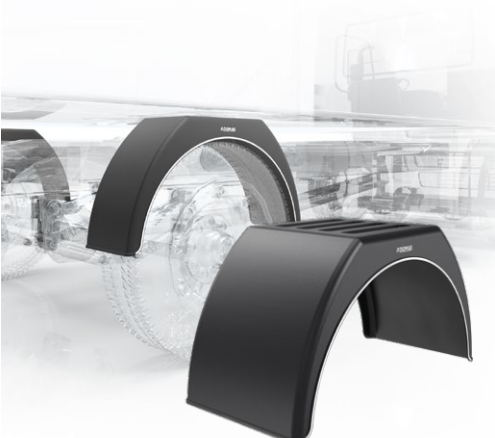

■ Aparator de noroi fără suport reglabil

Descriere	Cod produs	Lățime	Diametru	Lungime
Aparator de noroi	DK3110	260 mm	1450 mm	880 mm
Aparator de noroi	DK3115	450 mm	1480 mm	920 mm
Aparator de noroi	DK3120	510 mm	1770 mm	1000 mm
Aparator de noroi	DK3125	550 mm	1930 mm	1150 mm



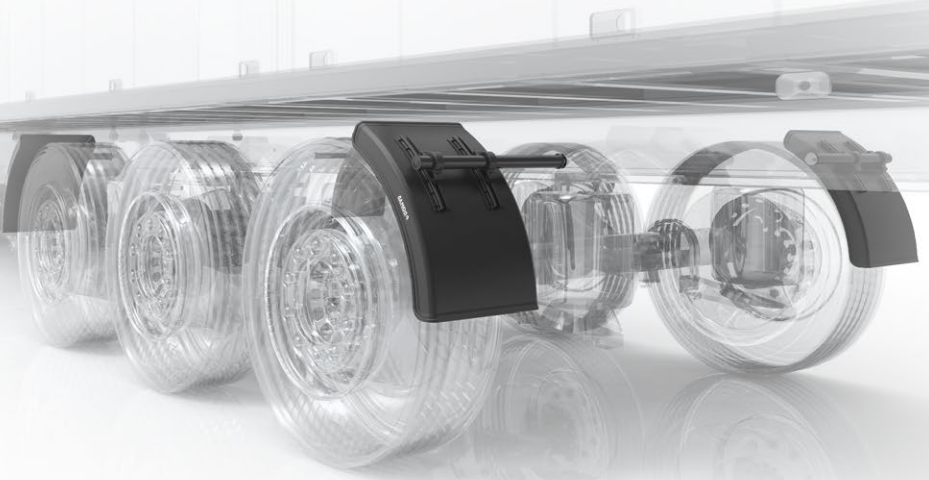

■ Aripă din plastic cu suport reglabil

Descriere	Cod produs	Versiuni			
			Lățime	Diametru	Lungime
Aripă din plastic	DK2010		430 mm	700 mm	670 mm
Aripă din plastic	DK2110	cu linie alb	430 mm	700 mm	670 mm
Aripă din plastic	DK2015		500 mm	700 mm	650 mm
Aripă din plastic	DK2115	cu linie alb	500 mm	400 mm	650 mm
Aripă din plastic	DK2030		670 mm	700 mm	670 mm
Aripă din plastic	DK2130	cu linie alb	670 mm	700 mm	670mm
Aripă din plastic	DK2035		430 mm	1000 mm	755 mm
Aripă din plastic	DK2135	cu linie alb	430 mm	1000 mm	755mm
Aripă din plastic	DK2040		500 mm	1000 mm	730 mm
Aripă din plastic	DK2140	cu linie alb	500 mm	1000 mm	730 mm
Aripă din plastic	DK2055		670 mm	700 mm	750 mm
Aripă din plastic	DK2155	cu linie alb	670 mm	700 mm	750 mm
Aripă din plastic	DK2060		430 mm	700 mm	910 mm
Aripă din plastic	DK2160	cu linie alb	430 mm	700 mm	910 mm
Aripă din plastic	DK2065		670 mm	700 mm	905 mm
Aripă din plastic	DK2165	cu linie alb	670 mm	800 mm	905 mm

■ Aparator de noroi fără suport reglabil

Descriere	Cod produs			
		Lățime	Diametru	Lungime
Aparator de noroi	DK1820	670 mm	1950 mm	1250 mm
Aparator de noroi	DK1830	450 mm	2125 mm	1365 mm
Aparator de noroi	DK1840	530 mm	2125 mm	1365 mm
Aparator de noroi	DK1850	690 mm	2125 mm	1365 mm





■ Aripă din plastic cu suport reglabil

Descriere	Cod produs	Versiuni	Lățime	Diametru	Lungime
Aripă din plastic	DK2575		430 mm	1900 mm	1300 mm
Aripă din plastic	DK2675	cu linie alb	430 mm	1900 mm	1300 mm
Aripă din plastic	DK2580		430 mm	2125 mm	1300 mm
Aripă din plastic	DK2680	cu linie alb	430 mm	2125 mm	1300 mm
Aripă din plastic	DK2585		670 mm	2125 mm	1340 mm
Aripă din plastic	DK2685	cu linie alb	670 mm	2125 mm	1340 mm



■ Aripă din plastic cu suport reglabil integrat

Descriere	Cod produs	Versiuni	Lățime	Diametru	Lungime
Aripă din plastic	DK2971		650 mm	2000 mm	1260 mm
Aripă din plastic	DK3071	cu linie alb	650 mm	2000 mm	1260 mm
Aripă din plastic	DK2975		430 mm	1900 mm	1250 mm
Aripă din plastic	DK3075	cu linie alb	430 mm	1900 mm	1250 mm
Aripă din plastic	DK2976		430 mm	2000 mm	1270 mm
Aripă din plastic	DK3076	cu linie alb	430 mm	2000 mm	1270 mm





■ Aripă din plastic pentru SCHMITZ, KRONE, KOGEL

Descriere	Cod produs	Lățime	Lungime
Aripă din plastic	181375403	440 mm	640 mm
Aripă din plastic	181375404	450 mm	730 mm
Aripă din plastic	181375405	450 mm	640 mm



■ Aripă din plastic pentru KRONE

Descriere	Cod produs	Lățime	Lungime
Aripă din plastic	181375338	490 mm	608 mm
Aripă din plastic	181375339	490 mm	412 mm



■ Suport reglabil pentru aripă



Descriere	Cod produs	Diametru	Lungime
Suport galvanizat	DN-101	42 mm	355 mm
Suport vopsit electrostatic	DN-102	42 mm	355 mm
Suport vopsit negru	DK8115	42 mm	355 mm
Suport plastic	DK8125	42 mm	355 mm



■ Suport HANSAFLEX pentru aripă

Descriere	Cod produs	Diametru
Suport galvanizat	274381253	42 mm

■ Tub drept pentru suport



Descriere	Cod produs	Diametru	Lungime
Tub vopsit electrostatic	DK8010	42 mm	580 mm
Tub vopsit electrostatic	DK8012	42 mm	800 mm



■ Tub curbat cu șurub pentru suport



Descriere	Cod produs	Diametru	Lungime
Tub curbat vopsit electrostatic	DK8024	42 mm	580 mm
Tub curbat vopsit electrostatic	DK8026	42 mm	800 mm

■ Tub curbat pentru suport



Descriere	Cod produs	Diametru	Lungime
Tub curbat vopsit electrostatic	DK8014	42 mm	580 mm
Tub curbat vopsit electrostatic	DK8016	42 mm	800 mm

■ Tub drept cu șurub pentru suport



Descriere	Cod produs	Diametru	Lungime
Tub drept vopsit electrostatic	DK8042	48 mm	800 mm

■ Tub drept cu șurub sudat pentru suport



Descriere	Cod produs	Diametru	Lungime
Tub drept vopsit electrostatic	DK8060	42 mm	580 mm
Tub drept vopsit electrostatic	DK8062	42mm	800 mm

■ Tub curbat cu șurub sudat pentru suport



Descriere	Cod produs	Diametru	Lungime
Tub curbat vopsit electrostatic	DK8064	42 mm	580 mm
Tub curbat vopsit electrostatic	DK8066	42 mm	800 mm

■ Suport pentru tub



Descriere	Cod produs	Diametru	Lungime
Suport galvanizat	DK8215	42 mm	100 mm
Suport plastic	DK8210	42 mm	100 mm



APARATOR DE NOROI



■ Suport cu gaură filetată pentru tub

Descriere	Cod produs	Diametru	Lungime
Suport galvanizat	DK8220	42 mm	100 mm

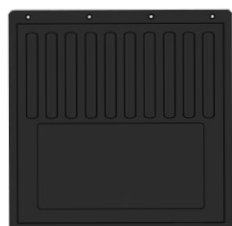

■ Aparator noroi universal

Descriere	Cod produs	Lățime	Lungime
Aparator noroi universal	NRM.01.001	400 mm	400 mm



■ Aparator noroi KRONE

Descriere	Cod produs	Lățime	Lungime
Aparator noroi KRONE	NRM.01.02	510 mm	420 mm



■ Aparator noroi WINKLER

Descriere	Cod produs	Lățime	Lungime
Aparator noroi WINKLER	571 000 302 00	300 mm	300 mm
Aparator noroi WINKLER	571 000 303 00	350 mm	300 mm
Aparator noroi WINKLER	571 000 304 00	400 mm	300 mm
Aparator noroi WINKLER	571 000 305 00	400 mm	400 mm
Aparator noroi WINKLER	571 000 306 00	400 mm	500 mm
Aparator noroi WINKLER	571 000 307 00	450 mm	300 mm
Aparator noroi WINKLER	571 000 308 00	450 mm	400 mm
Aparator noroi WINKLER	571 000 309 00	500 mm	300 mm
Aparator noroi WINKLER	571 000 310 00	500 mm	400 mm
Aparator noroi WINKLER	571 000 311 00	550 mm	300 mm
Aparator noroi WINKLER	571 000 314 00	600 mm	300 mm
Aparator noroi WINKLER	571 000 315 00	600 mm	400 mm
Aparator noroi WINKLER	571 000 462 00	600 mm	500 mm
Aparator noroi WINKLER	571 000 317 00	650 mm	300 mm
Aparator noroi WINKLER	571 000 318 00	650 mm	400 mm



APARATOR DE NOROI



■ Aparatoare noroi universal cu șuruburi

Descriere	Cod produs	Lățime	Lungime
Aparatoare noroi	571 000 01 00	260 mm	260 mm
Aparatoare noroi	571 000 02 00	300 mm	300 mm
Aparatoare noroi	571 000 03 00	350 mm	300 mm
Aparatoare noroi	571 000 04 00	400 mm	300 mm
Aparatoare noroi	571 000 05 00	400 mm	400 mm
Aparatoare noroi	571 000 06 00	400 mm	500 mm
Aparatoare noroi	571 000 07 00	450 mm	300 mm
Aparatoare noroi	571 000 08 00	450 mm	400 mm
Aparatoare noroi	571 000 09 00	500 mm	300 mm
Aparatoare noroi	571 000 10 00	500 mm	400 mm
Aparatoare noroi	571 000 11 00	550 mm	300 mm
Aparatoare noroi	571 000 12 00	550 mm	400 mm
Aparatoare noroi	571 000 13 00	550 mm	500 mm
Aparatoare noroi	571 000 14 00	600 mm	300 mm
Aparatoare noroi	571 000 15 00	600 mm	400 mm
Aparatoare noroi	571 000 16 00	600 mm	500 mm
Aparatoare noroi	571 000 17 00	650 mm	300 mm
Aparatoare noroi	571 000 18 00	650 mm	400 mm
Aparatoare noroi	571 000 20 00	700 mm	400 mm



■ Aparat noroi spate

Descriere	Cod produs	Lățime	Lungime
Aparat noroi	NRM.01.004	2400 mm	350 mm

NORMA

Authorized distributor
of EURORICAMBI



Produse populare

PIESE CUTII DE VITEZE

EURORICAMBI
PEOPLE. PASSION. GEARS.

Pe lângă gama completă de piese pentru camioane, punem la dispoziția partenerilor noștri și o ofertă completă de piese cutii de viteze camioane. În anul 2018 firma a devenit distribuitor autorizat de piese cutii de viteze Euroricambi.





■ Știft balamalei laterale

Descriere	Cod produs	Lățime	Lungime
Știft balamalei laterale	N010101	21,5 mm	90 mm

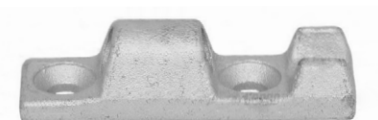

■ Balamale laterale

Descriere	Cod produs	Diametru	Lungime
Balamale laterale	N010102	26 mm	90 mm



■ Set balamale laterale

Descriere	Cod produs	Lungime
Set balamale laterale	N010103	90 mm



■ Șurub pentru balamaua ușii spate Schmitz

Descriere	Cod produs
Șurub pentru balamaua	N010104



■ Manșon pentru balamaua ușii spate Schmitz

Descriere	Cod produs
Manșon pentru balamaua	N010105



■ Balamale laterale pentru Schmitz Varios/Scs/Eloxiert

Descriere	Cod produs
Balamale	N010106

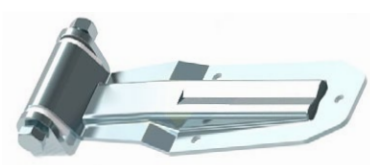

■ Balama ușă spate cu suport

Descriere	Cod produs	Lățime	Lungime
Balamale ușă spate	N010107	82 mm	255 mm



■ Balama ușă spate pentru Schmitz

Descriere	Cod produs	Lățime	Lungime
Balama ușă spate pt. Schmitz	N010108	64 mm	356 mm



■ Balama ușă spate pentru Schmitz

Descriere	Cod produs	Lățime	Lungime
Balama ușă spate pt. Schmitz	N010109	63 mm	330 mm

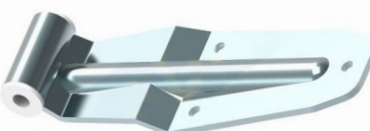

■ Balama ușă spate pentru Schmitz

Descriere	Cod produs	Lățime	Lungime
Balama ușă spate pt. Schmitz	N010110	63 mm	246 mm



■ Balama ușă spate pentru Schmitz

Descriere	Cod produs	Lățime	Lungime
Balama ușă spate pt. Schmitz	N010111	80 mm	295 mm



■ Balama ușă spate pentru Schmitz

Descriere	Cod produs
Balama ușă spate pt. Schmitz	N010112



■ **Fixare** balamalei ușii Schmitz pe stâlpul spr/SCS

Descriere	Cod produs
-----------	------------

Element fixare	N010201
----------------	----------------

■ **Șurub** balama pentru ușă din oțel Schmitz



Descriere	Cod produs	Lungime
-----------	------------	---------

Șurub balama	N010301	65 mm
--------------	----------------	-------

■ **Șurub** balama pentru ușă din oțel Schmitz



Descriere	Cod produs	Diametru	Lungime
-----------	------------	----------	---------

Șurub balama	N010302	16 mm	970 mm
--------------	----------------	-------	--------

■ **Balamala** ușă spate pentru Schmitz (2005)



Descriere	Cod produs
-----------	------------

Balamală ușă spate pt. Schmitz	N010113
--------------------------------	----------------

■ **Șurub** balama pentru ușă din oțel Krone stângă



Descriere	Cod produs
-----------	------------

Șurub balama stângă	N010303
---------------------	----------------

■ **Șurub** balama pentru ușă din oțel Krone dreaptă



Descriere	Cod produs
-----------	------------

Șurub balama dreaptă	N010304
----------------------	----------------



■ Balamala ușa spate pentru Krone

Descriere Cod produs

Balamale ușa spate pt. Krone **N010114**



■ Balama ușa spate completă pentru Kogel

Descriere Cod produs

Balama ușa spate pt. Kogel **N010115**



■ Sistem de blocare

Descriere Cod produs Lățime Lungime

Sistem de blocare **N010401** 264 mm 430 mm



■ Sistem blocare pentru ușile remorcii Krone

Descriere Cod produs

Sistem blocare **N010402**

Produse populare

PENTRU MII DE APLICAȚII

WD-40 SPECIALIST



NORMA



Produse speciale

PIESE DE ETRIERE CHEEFT



www.norma.identificarepiese.com.ro



■ Rolă pentru sistem TSE-Kogel

Descriere	Cod produs	Material	Diametru
Rolă TSE	N010501	metal	26 mm
Rolă TSE	N010502	plastic	26 mm



■ Rolă universală

Descriere	Cod produs	Lungime	Diametru
Rolă universală metal	N010503	16 mm	24 mm
Rolă universală metal	N010504	18 mm	24 mm
Rolă universală metal	N010505	21 mm	24 mm



■ Rolă pentru nitare

Descriere	Cod produs	Material	Diametru
Rolă pentru nitare	N010506	metal	24 mm
Rolă pentru nitare	N010507	metal	25 mm

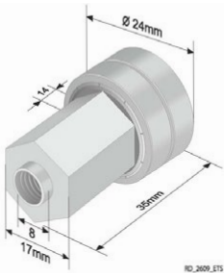

■ Rolă pentru sistem Etes și Sesam

Descriere	Cod produs	Material	Diametru
Rolă metal	N010508	metal	24mm

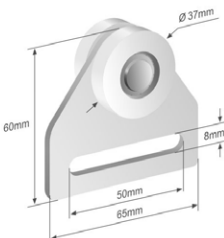

■ Rolă tip SP Edscha

Descriere	Cod produs	Material	Diametru
Rolă SP	N010509	metal	35 mm

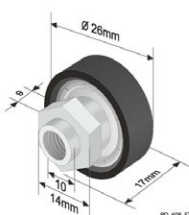

■ Rolă pentru sistem TSE2-Kogel

Descriere	Cod produs	Material	Diametru
Rolă TSE2	N010510	plastic	26 mm

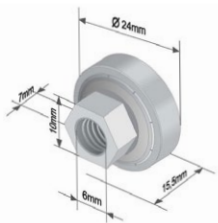

■ Rolă pentru sistem Edscha Eco Lite plus

Descriere	Cod produs	Material	Diametru
Rolă Eco	N010511	metal	24 mm

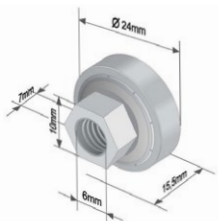

■ Rolă pentru sistem Etes

Descriere	Cod produs	Material	Diametru
Rolă Etes	N010512	metal	24 mm



■ Rolă pentru sistem Sesam

Descriere	Cod produs	Material	Diametru
Rolă pentru	N010513	metal	24 mm

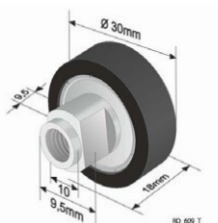

■ Rolă pentru sistem Schmitz TSE

Descriere	Cod produs	Material	Diametru
Rolă Schmitz TSE	N010514	metal	24mm

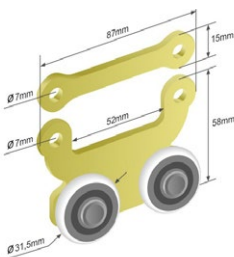

■ Rolă dublu Kogel

Descriere	Cod produs
Rolă dublu Kogel	N010515



■ Rolă prelată Edscha

Descriere	Cod produs
Rolă prelată	N010516

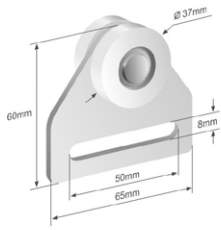

■ Rolă prelată cu gaură pt. centură

Descriere	Cod produs	Material
Rolă prelată	N010517	metal

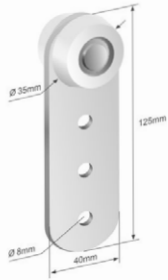

■ Rolă prelată tip E

Descriere	Cod produs	Material	Diametru
Rolă prelată tip E	N010518	metal	35 mm



■ Rolă prelată drept

Descriere	Cod produs	Material	Diametru
Rolă prelată	N010519	metal	35 mm

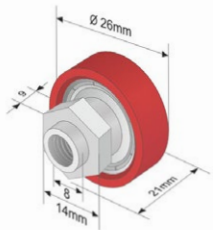

■ Rolă pentru sistem Versus

Descriere	Cod produs	Material	Diametru
Rolă metal	N010520	metal	26 mm

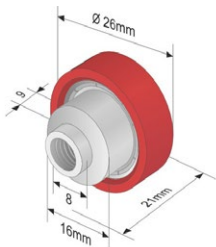

■ Rolă pentru sistem Versus

Descriere	Cod produs	Material	Diametru
Rolă Versus	N010521	plastic	26 mm

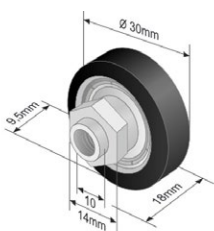

■ Rolă pentru sistem TSE-Schmitz (manșon hexagonal)

Descriere	Cod produs	Material	Diametru
Rolă TSE Schmitz	N010522	plastic	30 mm

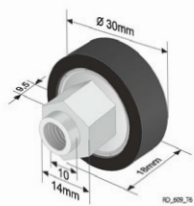

■ Rolă pentru sistem TSE-Schmitz (manșon hexagonal)

Descriere	Cod produs	Material	Diametru
Rolă TSE Schmitz	N010523	plastic	30 mm



■ Rolă universală pentru stâlpi

Descriere	Cod produs	Material	Diametru
Rolă (stâlpi)	N010524	metal	24 mm
Rolă (stâlpi)	N010525	metal	25 mm



■ Rolă pentru sistem TSE-Kogel

Descriere	Cod produs	Material	Diametru
Rolă pentru TSE-Kogel	N010526	metal	24 mm



■ Rolă pentru sistem Schmitz TSE

Descriere	Cod produs	Material	Diametru
Rolă Schmitz TSE	N010527	metal	24mm



■ Rolă pentru sistem TSE-Kogel

Descriere	Cod produs	Material	Diametru
Rolă pentru TSE-Kogel	N010528	metal	26 mm

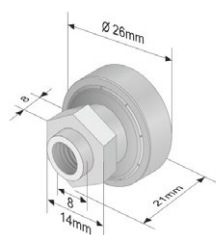

■ Rolă pentru sistem Versus

Descriere	Cod produs	Material	Diametru
Rolă pentru sistem Versus	N010529	metal	26 mm

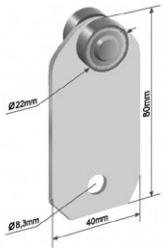

■ Rolă cu rulmenți galvanizate

Descriere	Cod produs	Material	Diametru
Rolă cu rulmenți galvanizate	N010530	metal	40 mm

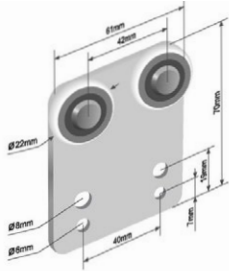

■ Rolă cu rulmenți galvanizate

Descriere	Cod produs	Material	Diametru
Rolă cu rulmenți galvanizate	N010531	metal	22 mm
Rolă cu rulmenți galvanizate	N010532	metal	24 mm

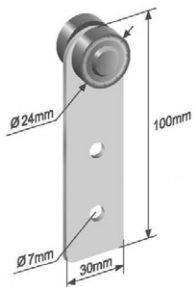

■ Rolă cu rulmenți galvanizate

Descriere	Cod produs	Material	Diametru
Rolă cu rulmenți galvanizate	N010533	metal	24 mm

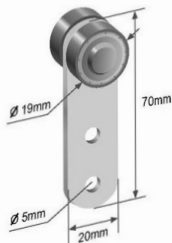

■ Rolă cu rulmenți galvanizate

Descriere	Cod produs	Material	Diametru
Rolă cu rulmenți galvanizate	N010534	metal	19 mm
Rolă cu rulmenți galvanizate	N010535	metal	22 mm



■ Rolă cu rulmenți galvanizate

Descriere	Cod produs	Material	Diametru
Rolă cu rulmenți galvanizate	N010536	metal	32 mm



■ Rolă cu rulmenți galvanizate

Descriere	Cod produs	Material	Diametru
Rolă cu rulmenți galvanizate	N010537	metal	32 mm

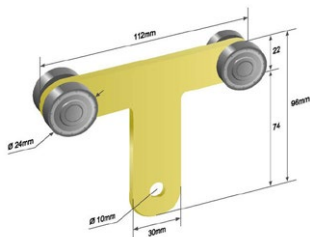

■ Rolă cu rulmenți galvanizate

Descriere	Cod produs	Material	Diametru
Rolă cu rulmenți galvanizate	N010538	metal	24 mm

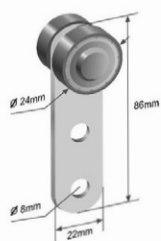

■ Rolă cu rulmenți galvanizate

Descriere	Cod produs	Material	Diametru
Rolă cu rulmenți galvanizate	N010539	metal	24 mm

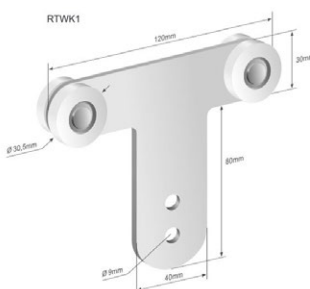

■ Rolă cu rulmenți galvanizate

Descriere	Cod produs	Material	Diametru
Rolă cu rulmenți galvanizate	N010540	metal	31 mm

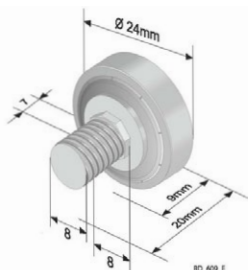

■ Rolă pentru sistem Edscha

Descriere	Cod produs	Material	Diametru
Rolă pentru sistem Edscha	N010541	metal	24 mm



■ Rolă pentru Schmitz

Descriere	Cod produs	Material	Diametru
Rolă pt. Schmitz	N010542	metal	28 mm

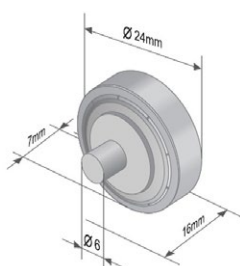

■ Rolă pentru sistem Edscha

Descriere	Cod produs	Material	Diametru
Rolă pentru sistem Edscha	N010543	metal	24 mm



■ Rolă pentru prelată culisantă

Descriere	Cod produs	Material	Diametru
Rolă	N010544	plastic	24 mm

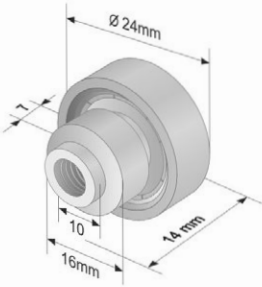

■ Rolă pentru prelată culisantă

Descriere	Cod produs	Material	Diametru
Rolă	N010545	plastic	24 mm

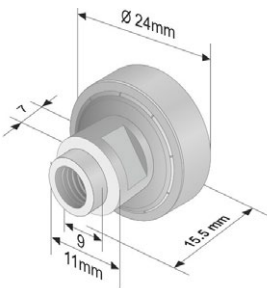

■ Rolă pentru prelată culisantă

Descriere	Cod produs	Material	Diametru
Rolă	N010546	plastic	24 mm

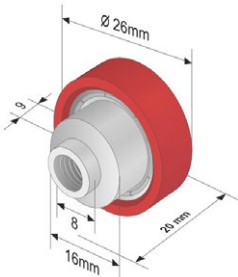

■ Rolă pentru prelată culisantă

Descriere	Cod produs	Material	Diametru
Rolă	N010547	plastic	24 mm

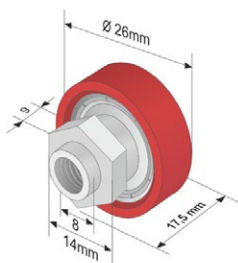

■ Rolă pentru prelată culisantă

Descriere	Cod produs	Material	Diametru
Rolă	N010548	plastic	24 mm

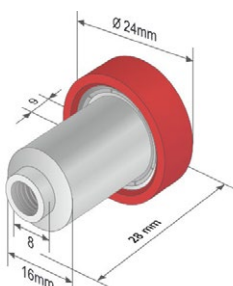

■ Rolă pentru prelată culisantă

Descriere	Cod produs	Material	Diametru
Rolă	N010549	plastic	24 mm

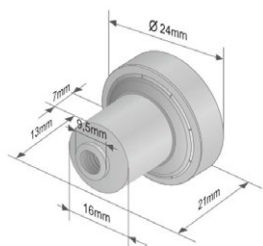

■ Rolă pentru prelată culisantă

Descriere	Cod produs	Material	Diametru
Rolă	N010550	metal	24 mm

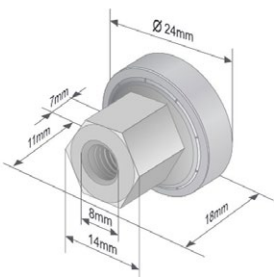

■ Rolă pentru prelată culisantă

Descriere	Cod produs	Material	Diametru
Rolă	N010551	metal	24 mm



■ Rolă pentru prelată culisantă

Descriere	Cod produs	Material	Diametru
Rolă	N010552	metal	24 mm



■ Cărucior transversă cu role Edscha

Descriere	Cod produs
Cărucior Edscha	N010601



■ Element acoperiș tip Sesam

Descriere	Cod produs	Lungime
Element acoperiș Sesam	N010602	689 mm



■ Element acoperiș tip Edscha

Descriere	Cod produs	Diametru
Element acoperiș tip Edscha	N010603	650 mm



■ Element acoperiș tip Edscha Ultraline

Descriere	Cod produs	Lungime
Element acoperiș tip Edscha Ultraline	N010604	625 mm



■ Element acoperiș tip Versus

Descriere	Cod produs	Lungime
Element acoperiș Versus	N010605	370 mm
Element acoperiș Versus	N010606	500 mm
Element acoperiș Versus	N010607	600 mm
Element acoperiș Versus	N010608	650 mm
Element acoperiș Versus	N010609	700 mm

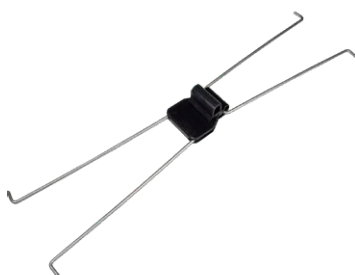

■ Element acoperiș tip Kogel

Descriere	Cod produs	Lungime
Element acoperiș tip Kogel	N010610	650 mm



■ Amortizor plafon pentru sistem Edscha

Descriere	Cod produs	Forța	Lungime
Amortizor plafon	N010701	950 N	210 mm



■ Amortizor plafon

Descriere	Cod produs	Forța	Lungime
Amortizor plafon	N010702	650 N	235 mm



■ Amortizor plafon

Descriere	Cod produs	Forța	Lungime
Amortizor plafon	N010703	1250 N	750 mm



■ Amortizor plafon

Descriere	Cod produs	Forța	Lungime
Amortizor plafon	N010704	500 N	205 mm



■ Amortizor plafon

Descriere	Cod produs	Forța	Lungime
Amortizor plafon	N010705	700 N	205 mm



■ Amortizor plafon pentru Edscha cu kit montare

Descriere	Cod produs	Forța	Lungime
Amortizor plafon cu kit	N010706	700 N	200mm



■ Amortizor plafon pentru Schmitz

Descriere	Cod produs	Forța	Lungime
Amortizor plafon	N010707	500 N	170 mm



■ Profil țevă aluminiu întindere prelata

Descriere	Cod produs	Diametru	Lungime
Profil țevă aluminiu	N010801	27 mm	3,3 m
Profil țevă aluminiu	N010802	27 mm	3,15 m



■ Adaptor țevă pentru Schmitz

Descriere	Cod produs	Mărime
Adaptor țevă	N010803	27 mm



■ Cap cu fantă pătrat (joasă)

Descriere	Cod produs	Mărime
Cap cu fantă	N010804	27 mm

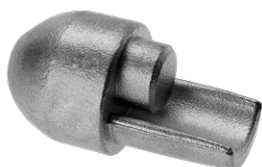

■ Cap de antrenare pentru țeavă de 27 mm.

Descriere	Cod produs	Mărime
Cap de antrenare	N010805	27 mm



■ Bucșă zincată

Descriere	Cod produs	Mărime
Bucșă zincată	N010806	27 mm



■ Clichet întindere prelată cu furcă Kogel partea dreaptă

Descriere	Cod produs
Clichet dreaptă	N010901



■ Clichet întindere prelată cu furcă Kogel partea stângă

Descriere	Cod produs
Clichet stângă	N010902

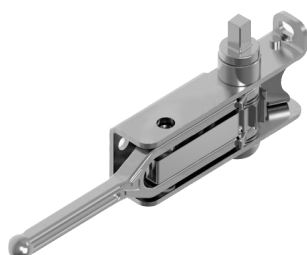

■ Clichet întindere prelată cu pătrat Kogel

Descriere	Cod produs
Clichet dreaptă	N010903
Clichet stângă	N010904



■ Clichet PWP cu furcă pt. întindere prelată

Descriere	Cod produs
-----------	------------

Clichet PWP stângă	N010905
--------------------	-------------------------

Clichet PWP dreaptă	N010906
---------------------	-------------------------



■ Clichet PWP cu pătrat pt. întindere prelată partea stânga

Descriere	Cod produs
-----------	------------

Clichet PWP stângă	N010907
--------------------	-------------------------



■ Clichet PWP cu pătrat pt. întindere prelată partea dreapta

Descriere	Cod produs
-----------	------------

Clichet PWP dreaptă	N010908
---------------------	-------------------------



■ Mecanism complet pt. tensionare prelată

Descriere	Cod produs	Material
Mecanism tensionare complet	N011001	inoxidabil
Mecanism tensionare complet	N011002	galvanizat



■ Chingă fixare prelată

Descriere	Cod produs	Material
Chingă fixare prelată	N011003	galvanizat



■ Mecanism complet pt. tensionare prelată

Descriere	Cod produs	Material
Mecanism tensionare complet	N011004	galvanizat
Mecanism tensionare complet	N011005	inoxidabil



■ Chingă fixare prelată

Descriere	Cod produs	Material
Chingă fixare prelată	N011006	inoxidabil
Chingă fixare prelată	N011007	galvanizat



■ Închizător pentru chingă prelată

Descriere	Cod produs	Material
Închizător pt. chingă	N011008	inoxidabil
Închizător pt. chingă	N011009	galvanizat



■ Sistem montare chingă prelată

Descriere	Cod produs	Mărire
Sistem motare chingă prelată	N011010	20x46 mm



■ Cataramă întindere prelată

Descriere	Cod produs	Culoare
Cataramă întindere prelată	N011011	negru
Cataramă întindere prelată	N011012	gri



■ Cataramă cu blocare cu arc întindere prelată

Descriere	Cod produs	Culoare
Cataramă cu blocare	N011013	negru
Cataramă cu blocare	N011014	gri



■ Cataramă cu blocare cu arc întindere prelată + cârlig cu nervuri

Descriere	Cod produs	Culoare
Cataramă cu blocare cu arc	N011015	negru



■ Priză tip N (7 pini)

Descriere	Cod produs
-----------	------------

Conexiune cu șurub	090 157 112
Conexiune cu papuc	090 157 113



■ Ștecher tip N (7 pini)

Descriere	Cod produs
-----------	------------

Conexiune cu șurub	090 157 715
Conexiune cu papuc	090 157 716



■ Priză tip S (31 pini)

Descriere	Cod produs
-----------	------------

Conexiune cu șurub	090 157 117
Conexiune cu papuc	090 157 118



■ Ștecher tip S (31 pini)

Descriere	Cod produs
-----------	------------

Conexiune cu șurub	090 157 718
Conexiune cu papuc	090 157 719



■ Ștecher 15P/24V (ISO 12098 ADR)

Descriere	Cod produs
-----------	------------

Ștecher 15P/24V ADR	241010
---------------------	------------------------



■ Ștecher 7P/24V (ISO 7638-1 ABS / EBS / ADR)

Descriere	Cod produs
-----------	------------

Ștecher 7P/24V ABS / EBS / ADR	241070
--------------------------------	------------------------



■ **Adaptor** scurt, ștecher 15P/24V (ISO 1098) cu 2x priză 7P/24V (ISO 1185 + ISO 3731)

Descriere	Cod produs
-----------	------------

Adaptor scurt ștecher cu 2x priză	311038
-----------------------------------	---------------



■ **Cablu** electric spirală 7P/24V tip N (ISO 1185)

Descriere	Cod produs
-----------	------------

Cablu electric spirală 7P/24V tip N	611049
-------------------------------------	---------------



■ **Cablu** electric spirală 7P/24V tip S (ISO 3731)

Descriere	Cod produs
-----------	------------

Cablu electric spirală 7P/24V tip S	611050
-------------------------------------	---------------



■ **Cablu** electric spirală 7P/24V (ISO 7638-1 ABS / EBS / ADR)

Descriere	Cod produs
-----------	------------

Cablu electric spirală 7P/24V ABS / EBS / ADR	641121
---	---------------



■ **Cablu** electric spirală 15P/24V (ISO 12098 ADR)

Descriere	Cod produs
-----------	------------

Cablu electric spirală 15P/24V ADR	641167
------------------------------------	---------------



■ **Cablu** electric spirală 7P/24V (ISO 7638-1 ABS / EBS / ADR)

Descriere	Cod produs
-----------	------------

Cablu electric spirală 7P/24V ABS / EBS / ADR	641313
---	---------------



■ Cablu „Euro 6 125 °C,, electric spirală 7P/24V (ISO 7638-1 ABS / EBS / ADR)

Descriere

Cod produs

Cablu Euro 6 128 °C 7P/24V

641327



■ Cablu „Euro 6 125 °C,, electric spirală 15P/24V (ISO 12098 ADR)

Descriere

Cod produs

Cablu Euro 6 128 °C 15P/24V ADR

641328



■ Ștecher 15P/24V (ISO 12098 ADR)

Descriere

Cod produs

Ștecher 15P/24V ADR

141053



■ Ștecher 7P/24V (ISO 7638-1 ABS / EBS / ADR)

Descriere

Cod produs

Ștecher 7P/24V ABS / EBS / ADR

141070



■ Adaptor - cablu cu ștecher 15P/24V (ISO 1098) și 2x priză 7P/24V (ISO 1185 + ISO 3731)

Descriere

Cod produs

Adaptor cablu cu ștecher și 2x priză

711076



■ Adaptor 12V cu 7 pin

Descriere

Cod produs

Adaptor 12V cu 7 pin

WTY-GNIANZDO 7 PIN



■ Adaptor 12V cu 13 pin

Descriere

Cod produs

Adaptor 12V cu 13 pin

[WTY-GNIANZDO 13 PIN](#)



■ Adaptor 12V cu 7 pin la 13 pin

Descriere

Cod produs

Adaptor 12V 7/13 pin

[WTY-ADAPTER 7/13 PIN](#)



■ Adaptor 12V cu 13 pin la 7 pin

Descriere

Cod produs

Adaptor 12V 13/7 pin

[WTY-ADAPTER 13 PIN 7DIN](#)



■ Adaptor 12V 13 pin

Descriere

Cod produs

Adaptor 12V 13 pin

[WTY 13 PIN](#)



■ Adaptor 12V 7 pin

Descriere

Cod produs

Adaptor 12V 7 pin

[WTY 7 PIN](#)



■ Cutie electric

Descriere

Cod produs

Cutie electric

[76-5100-047](#)



■ Antifurt rezervor camion cu sită universală

Descriere	Cod produs	Diametru
Antifurt 80	N020801	80 mm



■ Antifurt rezervor camion cu filet, cu glonț de siguranță

Descriere	Cod produs	Diametru
Antifurt cu filet și glonț de siguranță	N020802	80 mm



■ Antifurt rezervor camion cu filet, pentru Scania

Descriere	Cod produs	Diametru
Antifurt cu filet pentru Scania	N020803	60 mm



■ Antifurt rezervor camion cu filet, pentru Atego

Descriere	Cod produs	Diametru
Antifurt cu filet pentru Atego	N020804	80 mm



■ Antifurt rezervor camion cu lacat

Descriere	Cod produs	Diametru
Antifurt rezervor cu lacat	N020805	80 mm



■ Expander

Descriere	Cod produs	Diametru
Expander	N021104	8 mm
Expander	N021105	10 mm



■ Cablu vamal

Descriere	Cod produs	Lungime
Cablu vamal 13 m	N020301	13 m
Cablu vamal 14 m	N020302	14 m
Cablu vamal 15 m	N020303	15 m
Cablu vamal 16 m	N020304	16 m
Cablu vamal 18 m	N020305	18 m
Cablu vamal 20 m	N020306	20 m
Cablu vamal 22 m	N020307	22 m
Cablu vamal 26 m	N020308	26 m
Cablu vamal 32 m	N020309	32 m
Cablu vamal 33 m	N020310	33 m
Cablu vamal 34 m	N020311	34 m
Cablu vamal 38 m	N020312	38 m



■ Capăt cablu vamal

Descriere	Cod produs
Capăt cablu vamal	N020402



■ Bridă (suport) cablu vamal

Descriere	Cod produs
Bridă cablu vamal U	N020401
Bridă cablu vamal P	N020403



■ Capsă prelată rotund

Descriere	Cod produs	Diametru
Capsă rotund 25 mm	N021101	25 mm
Capsă rotund 40 mm	N021102	40 mm



■ Capsă prelată ovală

Descriere	Cod produs
Capsă prelată ovală 38x2	N021103



■ Bandă reflectorizantă

Descriere	Cod produs	Culori	Tipuri
Bandă reflectorizantă	N020901	Alb	Înterupt
Bandă reflectorizantă	N020902	Galben	Înterupt
Bandă reflectorizantă	N020903	Roșu	Înterupt
Bandă reflectorizantă	N020904	Gri	Înterupt
Bandă reflectorizantă	N020905	Alb	Simplu
Bandă reflectorizantă	N020906	Galben	Simplu
Bandă reflectorizantă	N020907	Roșu	Simplu
Bandă reflectorizantă	N020908	Gri	Simplu



■ Bandă reflectorizantă gabarit

Descriere	Cod produs	Culori	Tipuri
Bandă reflectorizantă gabarit	N020909	Alb/Roșu	Dreaptă
Bandă reflectorizantă gabarit	N020910	Alb/Roșu	Stângă

■ Plăcuță reflectorizantă „Long Vehicle„



Descriere	Cod produs	Lungime	Înălțime
Plăcuță reflectorizantă Long Vehicle	N021006	1130 mm	200 mm

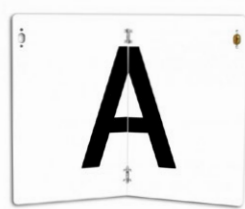

■ Plăcuțe tip: A

Descriere	Cod produs	Lungime	Înălțime
Plăcuțe A pliabil	NRM.AS.PG.A1	350 mm	250 mm
Plăcuțe A fix	NRM.AS.PG.A2	350 mm	250 mm



■ Set plăcuțe reflectorizante

Descriere	Cod produs	Lungime	Înălțime
Plăcuțe reflectorizante	N021004	565 mm	200 mm



■ Set autocolante reflectorizante

Descriere	Cod produs	Lungime	Înălțime
Autocolante reflectorizante	N021005	565 mm	200 mm



■ Set plăcuțe reflectorizante

Descriere	Cod produs	Lungime	Înălțime
Plăcuțe reflectorizante	N021003	565 mm	200 mm



■ Set autocolante reflectorizante

Descriere	Cod produs	Lungime	Înălțime
Autocolante reflectorizantă	N021007	1130 mm	200 mm



■ Plăcuță reflectorizantă gabarit dreapă

Descriere	Cod produs
Plăcuță reflectorizantă gabarit	N021002



■ Plăcuță reflectorizantă gabarit stângă

Descriere	Cod produs
Plăcuță reflectorizantă gabarit	N021001



■ Matrițe (autocolant) de viteze

Descriere	Cod produs	Descriere	Cod produs
Matriță 50km/h (mic)	N020501	Matriță 50km/h (mare)	N020509
Matriță 60km/h (mic)	N020502	Matriță 60km/h (mare)	N020510
Matriță 70km/h (mic)	N020503	Matriță 70km/h (mare)	N020511
Matriță 80km/h (mic)	N020504	Matriță 80km/h (mare)	N020512
Matriță 90km/h (mic)	N020505	Matriță 90km/h (mare)	N020513
Matriță 100km/h (mic)	N020506	Matriță 130km/h (mare)	N020514
Matriță 110km/h (mic)	N020507		
Matriță 130km/h (mic)	N020508		



■ Matriță (autocolant) Angles Morts

Descriere	Cod produs
Matriță Angles Morts	N020515

■ Extinctor pulbere



Descriere	Cod produs	Tipuri
Extinctor	N020101	1 kg
Extinctor	N020102	2 kg
Extinctor	N020103	3 kg
Extinctor	N020104	6 kg

■ Suport (cutie) extingtor



Descriere	Cod produs
Suport extingtor	N020105



SISTEME DE PRINDERE DE ÎNCĂRCARE



■ Chingă pentru fixare marfă 0,5 - 2 tone

Descriere	Cod produs	Lungime
Chingă 0,5T	N020709	5 m
Chingă 2T	N020701	3,3 m
Chingă 2T	N020702	3 m
Chingă 2T	N020703	4 m
Chingă 2T	N020704	6 m



■ Chingă pentru fixare marfă 5 tone

Descriere	Cod produs	Lungime
Chingă 5T	N020705	7,5 m
Chingă 5T	N020706	8 m
Chingă 5T	N020707	10 m
Chingă 5T	N020708	12 m

TREBUIE SĂ ÎNLOCUIEȘTI O PIESĂ LA SEMIREMORCĂ?

Piese și perne aer semiremorci **BPW, Krone, Saf, Kogel, Schmitz Cargobull**. Poți căuta piesele pe magazinul online cu coduri piesei.

NORMA

Authorized distributor
of EURORICAMBI



www.norma.com.ro



www.norma.pieseidentificare.ro



■ Bară fixare marfă

Descriere	Cod produs	Lungime	Înălțime
Bară fixare marfă	N030101	2400 mm - 2700 mm	125 mm



■ Colțar protecție bandă chingă

Descriere	Cod produs	Lungime	Înălțime
Colțar protecție bandă chingă	N030201	130 mm	81 mm



■ Lanț ancorare 4 - 6,3T cu două cărlige

Descriere	Cod produs	Lungime
Lanț ancorare 4 tone	N030301	3,5 m
Lanț ancorare 6,3 tone	N030302	3,5 m
Lanț ancorare 6,3 tone (Pewag)	N030303	3,5 m



■ Covoare antialunecare

Descriere	Cod produs	Grosime
Rolă 5m x 0,25m x 3mm	N030501	3 mm
Rolă 5m x 0,25m x 7mm	N030502	7 mm



■ Inel fixare marfă

Descriere	Cod produs	Distanță într. șurub	Înălțime
Inel fixare	N030401	50 mm	96 mm



■ Inel fixare marfă

Descriere	Cod produs	Distanță într. șurub	Înălțime
Inel fixare	N030402	53 mm	110 mm



■ Inel fixare marfă

Descriere	Cod produs	Lățime	Lungime
Inel fixare	N030403	101 mm	150 mm



■ Inel fixare marfă

Descriere	Cod produs	Lățime	Lungime
Inel fixare	N030404	30 mm	92 mm



■ Inel fixare marfă

Descriere	Cod produs	Lățime	Lungime
Inel fixare	N030405	100 mm	100 mm



■ Inel fixare marfă

Descriere	Cod produs	Lățime	Înălțime
Inel fixare	N030406	50 mm	110 mm



■ Inel fixare marfă

Descriere	Cod produs	Distanță într. șurub	Înălțime
Inel fixare	N030407	50 mm	110 mm



■ Inel fixare marfă

Descriere	Cod produs	Distanță într. șurub	Înălțime
Inel fixare	N030408	50 mm	110 mm



■ Rezervor apă (plastic) 10 - 20 litri cu robinet

Descriere	Cod produs	Capacitate
Rezervor pentru apă 10 l	N040101	10 litri
Rezervor pentru apă 20 l	N040102	20 litri



■ Rezervor apă (plastic) 30 litri cu robinet(plastic) și cu suport pentru săpun

Descriere	Cod produs	Dimensiuni	Cap.
Rezervor pentru apă 30 litri	N040103	370x350x410	30 litri
Rezervor pentru apă 30 litri	N040104	450x410x450	30 litri

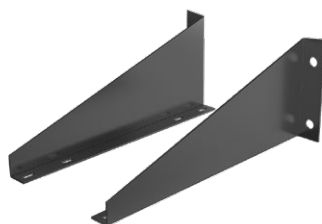

■ Suport pentru rezervor apă 30 litri

Descriere	Cod produs
Suport pentru rezervor apă	N040105



■ Cală blocare roți

Descriere	Cod produs	Roată
Cală blocare roți cu suport 17,5	N040401	17,5 inch
Cală blocare roți cu suport 22,5	N040402	22,5 inch
Cală blocare roți fără suport 17,5	N040403	17,5 inch
Cală blocare roți fără suport 22,5	N040404	22,5 inch

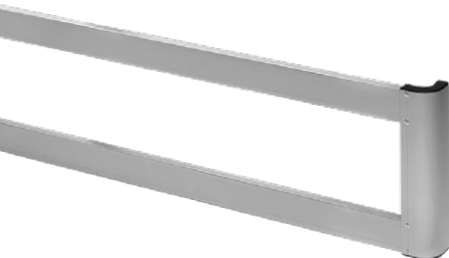

■ Bară de protecție aluminiu completă anodizat (parabicicliști)

Descriere	Cod produs	Lungime
Bară de protecție aluminiu complet	N040201	3000 mm



■ Bară de protecție aluminiu anodizat (parabicicliști)

Descriere	Cod produs	Dimensiuni
Bară de protecție aluminiu	N040202	3500x100x35 mm
Bară de protecție aluminiu	N040203	3000x100x35 mm

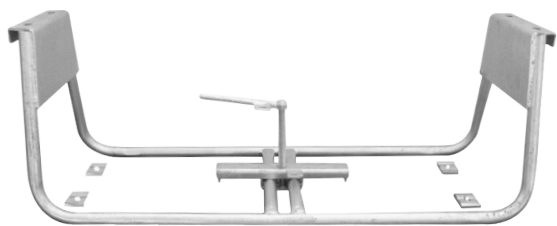

■ Suport de roată rezervă simplu

Descriere	Cod produs
-----------	------------

Suport de roată de rezervă (grund alchidic)	N040301
---	----------------

Suport de roată de rezervă (galvanizat)	N040302
---	----------------

Lățime	Înălțime	Lungime
--------	----------	---------

500 mm	450 mm	1200 mm
--------	--------	---------



■ Suport de roată rezervă dublu

Descriere	Cod produs
-----------	------------

Suport de roată de rezervă (grund alchidic)	N040303
---	----------------

Suport de roată de rezervă (galvanizat)	N040304
---	----------------

Lățime	Înălțime	Lungime
--------	----------	---------

1200 mm	520 mm	1570 mm
---------	--------	---------



■ Fixare roată pentru Schmitz

Descriere	Cod produs	Cod OE
-----------	------------	--------

Fixare roată pentru Schmitz	N040305	280540
-----------------------------	----------------	---------------



■ Troliu de mână pentru suport

Descriere	Cod produs
-----------	------------

Troliu de mână	N040306
----------------	----------------



■ Troliu de mână pentru suport

Descriere	Cod produs
-----------	------------

Troliu de mână	N040307
----------------	----------------



■ Fixare roată rezervă

Descriere	Cod produs	Dimens.	Greutate
-----------	------------	---------	----------

Fixare roată	N040308	455x340 mm	2 kg
--------------	----------------	------------	------



N040309

■ Suport de roată rezervă dublu

Descriere	Cod produs	Lățime 1	Înălțime 1	Lățime 2	Lungime	Greutate
Suport de roată de rezervă dublu	N040309	1190 mm	498 mm	1230 mm	1836 mm	36,3 kg



N040310



N040311

■ Suport de roată rezervă simplu

Descriere	Cod produs	Lățime	Înălțime	Lungime	Greutate
Suport de roată de rezervă simplu	N040310	1190 mm	498 mm	1740 mm	17,5 kg
Sup. de roată de rezervă înșurubat	N040311	1190 mm	498 mm	1740 mm	17,5 kg



■ Ladă scule Lago pentru semiremorci

Descriere	Cod produs	Înălțime	Lățime	Adâncime
Ladă scule pentru semiremorci	N040501	500 mm	1000 mm	470-490 mm
Ladă scule pentru semiremorci	N040502	450 mm	800 mm	470-490 mm
Ladă scule pentru semiremorci	N040503	450 mm	600 mm	470-490 mm



■ Ladă scule pentru semiremorci

Descriere	Cod produs	Înălțime	Lățime	Adâncime
Ladă scule Schmitz	N040504	445 mm	650 mm	445 mm
Ladă scule	N040505	530 mm	650 mm	650 mm
Ladă scule	N040506	530 mm	650 mm	445 mm

PIESE **KNOTT** PENTRU REMORCI

**DISPOZITIVE DE FRÂNARE, ACCESORII ELECTRICE,
ROȚI, TAMBURI, CABLURI DE FRÂNĂ, SABOȚI, CU-
PLE, BUCȘE...**



Pentru piese Knott [click aici](#).

Pentru cabluri de frână Knott [click aici](#).



■ Adaptor capăt



Descriere	Cod produs	Material
Adaptor capăt 11x3,5/m16x1,5x60	N050201	Metal
Adaptor capăt 11x3,5/m22x1,5x60	N050202	Metal

■ Adaptor reducție



Descriere	Cod produs	Material
Adaptor reducție	N050203	Metal

■ Adaptor reducție



Descriere	Cod produs	Material
Adaptor reducție	N050204	Metal

■ Supapă de rezervor aer



Descriere	Cod produs	Material
Supapă de rezervor aer	N050301	Metal

■ Adaptor reducție cu capac



Descriere	Cod produs	Material
Adaptor reducție cu capac M16/M16	N050205	Metal
Adaptor reducție cu capac M16/M22	N050206	Metal



■ **Cuplă rapidă** aer tip cruce M16 int. (x4)

Descriere	Cod produs	Material
Cuplă rapid aer tip cruce cu filet interior M16 x 4	N050101	Metal



■ **Cuplă rapidă** aer tip T M16 int. (x3)

Descriere	Cod produs	Material
Cuplă rapid aer tip T cu filet interior M16 x 3	N050102	Metal



■ **Cuplă rapidă** aer tip T M16 int./M16 ext./M16 int.

Descriere	Cod produs	Material
Cuplă rapid aer tip T cu filet interior M16 / filet exterior M16 / filet interior M16	N050103	Metal



■ **Cuplă rapidă** aer tip T M16 int./M16 int./M16 ext.

Descriere	Cod produs	Material
Cuplă rapid aer tip T cu filet interior M16 / filet interior M16 / filet exterior M16	N050104	Metal



■ **Cot cuplă rapidă** aer 90 grade, M16 int./M16 ext.

Descriere	Cod produs	Material
Cuplă rapid aer tip T cu filet interior M16 / filet exterior M16	N050105	Metal



FURTUN AER ȘPIRALAT

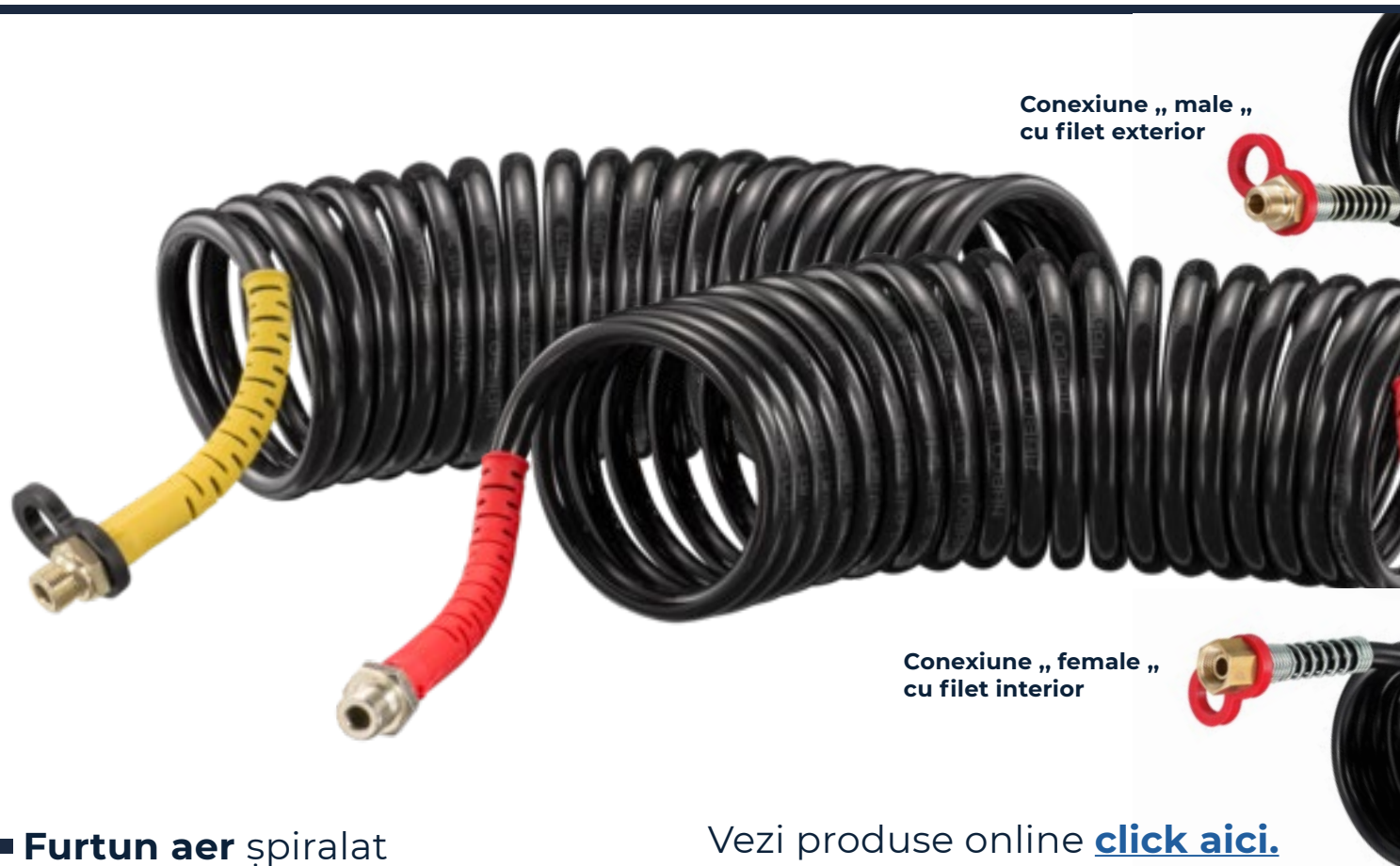

■ Furtun aer șpiralat

Vezi produse online [click aici.](#)

Cod Wabco	Tub	Protecție	Lungime	Conexiune
452 711 056 0	negru	roșu	550 mm	1, 2: male M16×1.5
452 711 057 0	negru	galben	550 mm	1, 2: male M16×1.5
452 711 058 0	negru	roșu	550 mm	1, 2: male M22×1.5
452 711 059 0	negru	galben	550 mm	1, 2: male M22×1.5
452 711 060 0	negru	roșu	556 mm	1: male M16×1.5; 2: female M18×1.5
452 711 061 0	negru	galben	556 mm	1: male M16×1.5; 2: female M18×1.5
452 711 062 0	negru	roșu	562 mm	1, 2: female M18×1.5
452 711 063 0	negru	galben	562 mm	1, 2: female M18×1.5
452 711 064 0	negru	negru	562 mm	1, 2: female M18×1.5
452 711 065 0	negru	negru	556 mm	1: male M16×1.5; 2: female M18×1.5
452 711 066 0	negru	roșu	550 mm	1: male M16×1.5; 2: male M18×1.5
452 711 067 0	negru	galben	550 mm	1: male M16×1.5; 2: male M18×1.5
452 711 068 0	negru	negru	550 mm	1: male M16×1.5; 2: male M18×1.5
452 711 069 0	negru/negru	galben/red	730 mm	1, 2: female M18×1.5
452 711 903 0	albastru/roșu	black/black	730 mm	1, 2: female M18×1.5 / male ½" BSP
452 711 904 0	negru/negru	galben/red	980 mm	1, 2: male ½" BSP external
452 713 001 0	roșu	roșu	700 mm	1, 2: male M16×1.5
452 713 002 0	galben	galben	700 mm	1, 2: male M16×1.5
452 713 003 0	negru	roșu	700 mm	1, 2: male M16×1.5
452 713 004 0	negru	galben	700 mm	1, 2: male M16×1.5
452 713 005 0	galben/roșu	galben/roșu	700 mm	1, 2: male M16×1.5
452 713 006 0	negru/negru	galben/roșu	700 mm	1, 2: male M16×1.5
890 034 293 0	negru/negru	galben/roșu	800 mm	1, 2: male M16×1.5



■ Bara spate protecție remorcă / semiremorcă

Descriere	Cod produs	Dimensiuni
Bară spate protecție	N060101	2400 mm x 220 mm



■ Bara spate protecție remorcă / semiremorcă fără gauri

Descriere	Cod produs	Dimensiuni
Bară spate protecție	N060102	2400 mm x 270 mm



■ Tampon cauciuc remorcă

Descriere	Cod produs	Dimensiuni
Tampon cauciuc remorcă	N060201	152 x 123 x 75 (mm)



■ Tampon cauciuc remorcă

Descriere	Cod produs	Dimensiuni
Tampon cauciuc remorcă	N060202	380 x 65 x 70 (mm)



■ Tampon cauciuc remorcă

Descriere	Cod produs	Dimensiuni
Tampon cauciuc remorcă	N060203	380 x 95 x 50 (mm)



■ Tampon cauciuc remorcă

Descriere	Cod produs	Dimensiuni
Tampon cauciuc remorcă	N060204	170 x 130 x 60 (mm)



■ Tampon cauciuc remorcă



Descriere	Cod produs	Dimensiuni
Tampon cauciuc remorcă	N060205	190 x 75 x 55 (mm)

■ Tampon cauciuc remorcă



Descriere	Cod produs	Dimensiuni
Tampon cauciuc remorcă	N060206	200 x 150 x 80 (mm)

■ Tampon cauciuc remorcă



Descriere	Cod produs	Dimensiuni
Tampon cauciuc remorcă	N060207	200 x 80 x 70 (mm)

PICIOARE SUSȚINERE SEMIREMORCĂ

ACCESORII ȘI PIESE PENTRU PICIOARE SUSȚINERE





■ Controler, înălțime suspensie

Descriere

Cod produs

Controler, înălțime suspensie

[076.510-00A](#)



■ Controler, înălțime suspensie

Descriere

Cod produs

Controler, înălțime suspensie

[076.513-00A](#)



■ Controler, înălțime suspensie

Descriere

Cod produs

Controler, înălțime suspensie

[076.511-00A](#)



■ Controler, înălțime suspensie

Descriere

Cod produs

Controler, înălțime suspensie

[076.512-00A](#)



■ Diagrame tahograf 100 km/h

Descriere

Cod produs

Diagrame tahograf 100 km/h

N070101



■ Diagrame tahograf 125 km/h

Descriere

Cod produs

Diagrame tahograf 125 km/h

N070102



■ Diagrame tahograf 140 km/h

Descriere

Cod produs

Diagrame tahograf 140 km/h

N070103



■ Diagrame tahograf 180 km/h

Descriere

Cod produs

Diagrame tahograf 180 km/h

N070104



■ Role tahograf digital

Descriere

Cod produs

Plăcuță reflectorizantă gabarit

N070201

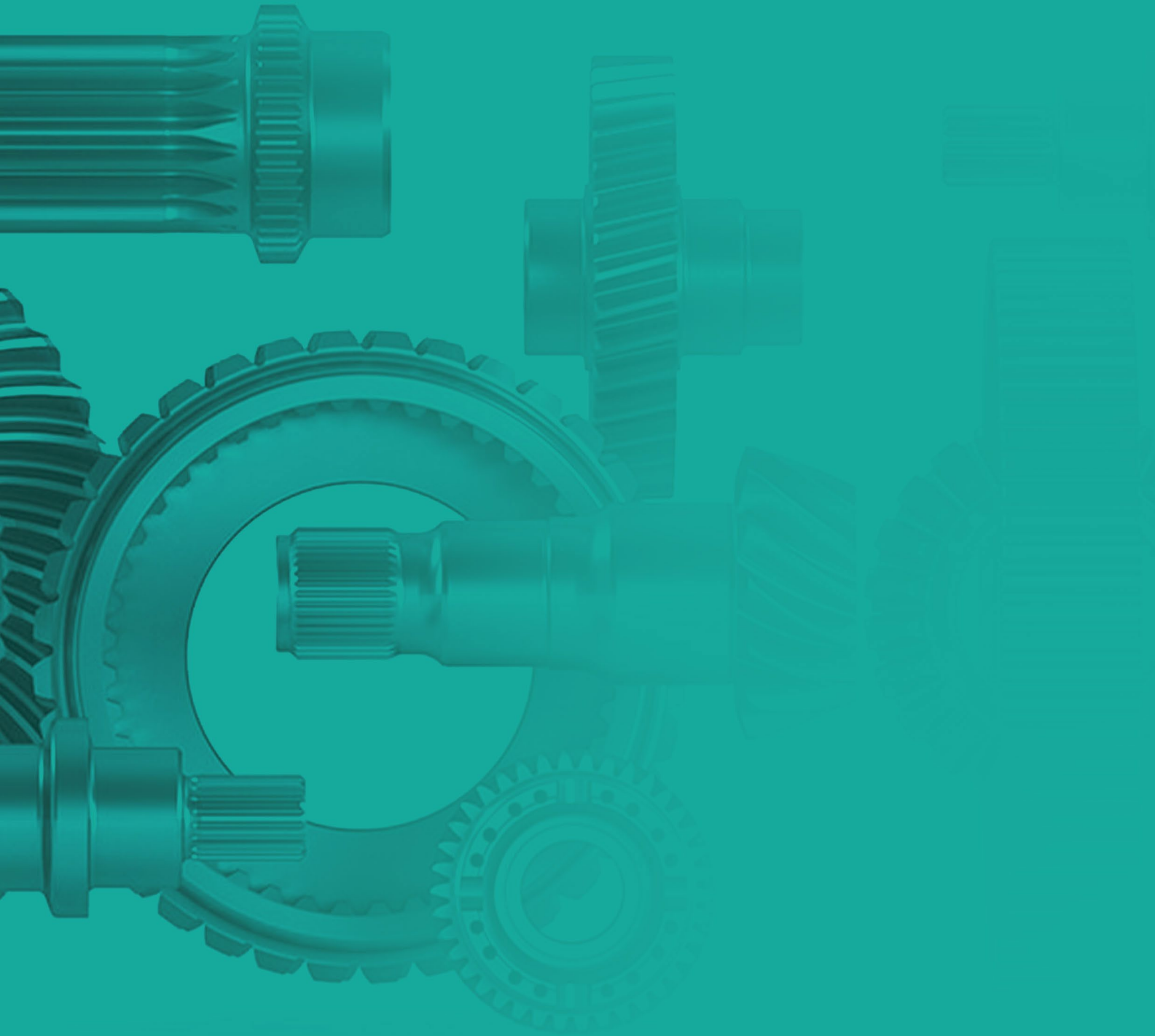

NORMA

Authorized distributor
of EURORICAMBI

